

FICHE D'HOMOLOGATION / HOMOLOGATION FORM

002-B4-60



COMMISSION
INTERNATIONALE
DE KARTING - FIA



SYSTEME DE FREINAGE / BRAKING SYSTEM 4 WP

Constructeur / <i>Manufacturer</i>	CRG srl
Marque / <i>Make</i>	CRG
Modèle / <i>Model</i>	VEN 13 KZ
Catégorie / <i>Category</i>	Boîte de vitesses / <i>Gearbox</i>
Durée de l'homologation / <i>Validity of the Homologation</i>	2 ans / <i>2 years</i>
Nombre de pages / <i>Number of pages</i>	4
La présente Fiche d'Homologation reproduit descriptions, illustrations et dimensions du système de freinage au moment de l'homologation CIK-FIA.	<i>This Homologation Form reproduces descriptions, illustrations and dimensions of the braking system at the time of the CIK-FIA homologation.</i>



Photo vue de dessus du système complet / *Photo from above of complete system*

**Signature et tampon de l'ASN /
Signature and stamp of the ASN**



**Signature et tampon de la CIK-FIA /
Signature and stamp of the CIK-FIA**



A

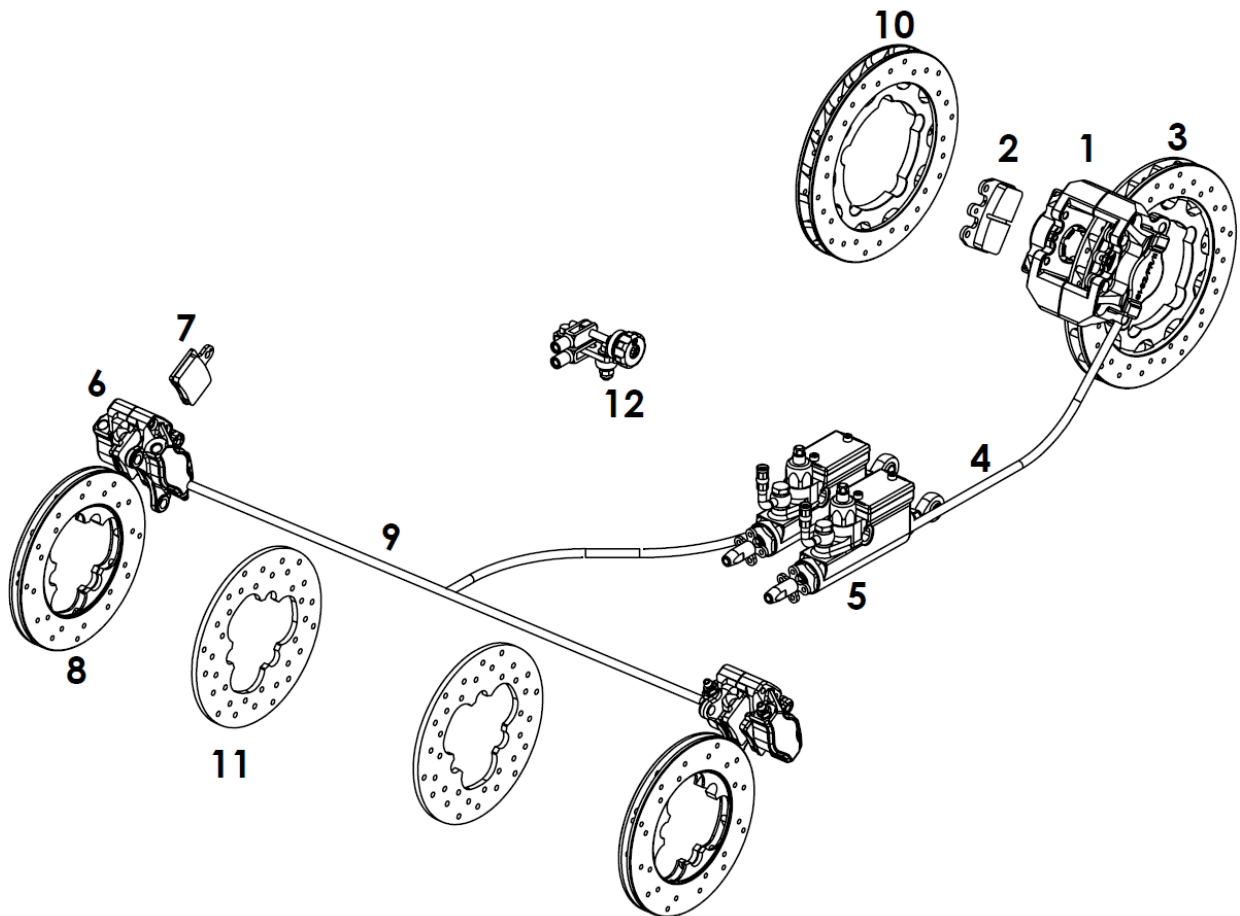

Dessin technique / Technical drawing
Dessin technique explosé / Exploded technical drawing









**Le dessin technique doit montrer les éléments ci-après : maître-cylindre, régulateur, répartiteur, tuyaux, étriers, plaquettes et disques (numérotation selon tableau ci-dessous) /
The technical drawing must show the following: Master cylinder, regulator, distributor, lines, calipers, pads and discs (with numbering according to the table below)**

N°	Désignation / Designation	Référence catalogue / Catalogue reference
1	ÉTRIERS ARRIÈRE / REAR CALIPER	FMG.04962
2	PLAQUETTES ARRIÈRE / REAR PAD	AFS.01745
3	DISQUES ARRIÈRE / REAR DISC 191	FL1.05320
4	TUYAUX ARRIÈRE / REAR LINE	AFS.00240
5	MAITRE-CYLINDRE / MASTER CYLINDER	FM0.05362
6	ÉTRIERS AVANT / FRONT CALIPER	FM0.0363D/S
7	PLAQUETTES AVANT / FRONT PAD	AFS.02997
8	DISQUES AVANT / FRONT DISC Vent	FL1.04225
9	TUYAUX AVANT / FRONT LINE	AFS.00336
10	DISQUES ARRIÈRE / ARRIÈRE REAR DISC 179	FL1.05827
11	DISQUES AVANT / FRON DISC	FL1.04242
12	RÉPARTITEUR / DISTRIBUTOR	FM0.05027

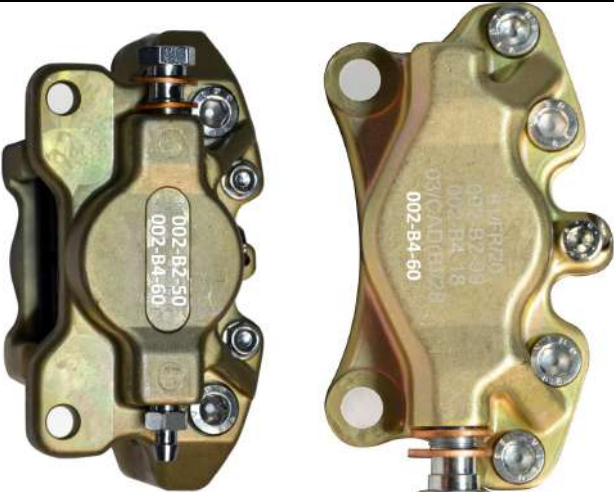
B	Description technique / Technical description		
Régulateur de freinage / <i>Braking regulator</i>	Oui / Yes		
	Avant / Front	Arrière / Rear	
Nombre de maîtres-cylindres / <i>Number of master cylinders</i>	1	1	
Ø Alésage / Bore Ø	Ø22.0 mm	Ø22.0 mm	
Nombre de pistons / <i>Number of pistons</i>	2	2	par étrier / per caliper
Ø alésage de l'étrier / <i>Caliper bore Ø</i>	Ø26.0 mm	Ø30.0 mm	
Nombre de plaquettes / <i>Number of pads</i>	2	2	par étrier / per caliper
Nombre d'étriers / <i>Number of calipers</i>	2	1	
Matériau des étriers / <i>Caliper material</i>	Aluminum	Aluminum	
Disque ventilé / <i>Ventilated disc</i>	Oui / Yes Non / No	Oui / Yes	
Epaisseur du disque neuf / <i>Thickness of new disc</i>	4.8 / 12.8 mm	17.0 / 18.0 mm	± 1 mm
Ø extérieur du disque / <i>External Ø of the disc</i>	154.0 / 154.0 mm	179.0 / 191.0 mm	± 1.5 mm
Longueur hors-tout des plaquettes / <i>Overall length of the pads</i>	38.0 mm	58.0 mm	± 1.5 mm
Longueur du matériau de friction / <i>Length of the friction material</i>	37.0 mm	57.0 mm	± 1.5 mm
Hauteur du matériau de friction / <i>Height of the friction material</i>	29.5 mm	29.5 mm	± 1.5 mm

C	Photo des freins / Photo of brakes	
		
	Etrier et disque avant uniquement / <i>Front caliper and disc only</i>	Etrier et disque arrière uniquement / <i>Rear caliper and disc only</i>

D	Photo du marquage du numéro d'homologation / Photo of the homologation number marking	
Maitre-cylindre / Master cylinder	Tuyaux / Lines	
		
Etriers / Calipers	Plaquettes / Pads	
		
Disques / Discs	Régulateur complet / Complete regulator	
		
<p>Le marquage doit rester clairement visible en permanence. / The marking must be clearly visible at all times.</p>		